

# Cable-Extension Position Transducer

DeviceNET®

Ranges: 0-10 to 0-250 inches

Industrial Grade

# PT5DN

## Specification Summary:

### GENERAL

Full Stroke Ranges ..... 0-10 to 0-250 inches  
 Electrical Interface ..... CANbus ISO 11898  
 Protocol ..... DeviceNET version 2.0  
 Accuracy .....  $\pm 0.25\%$  to  $\pm 0.10\%$  full stroke  
 Repeatability .....  $\pm 0.02\%$  full stroke  
 Resolution .....  $\pm 0.003\%$  full stroke  
 Measuring Cable ..... stainless steel or thermoplastic  
 Enclosure Material ..... hard anodized aluminum  
 Sensor ..... plastic-hybrid precision potentiometer  
 Potentiometer Cycle Life ..... *see ordering information*  
 Maximum Retraction Acceleration ..... *see ordering information*  
 Weight ..... 5 lbs. max.

### ELECTRICAL

Input Voltage ..... bus powered  
 Input Current ..... 40 mA  
 Address Setting/Node ID ..... 0...63 set via DIP switches—*default setting: 63*  
 Baud Rate ..... 125K, 250K or 500K set via DIP switches  
 EDS File ..... available @ <http://www.celesco.com/download>

### ENVIRONMENTAL

Environmental Suitability ..... NEMA 4/6, IP 67  
 Operating Temperature ..... -40° to 185°F (-40° to 85°C)  
 Vibration ..... up to 10 G's to 2000 Hz maximum

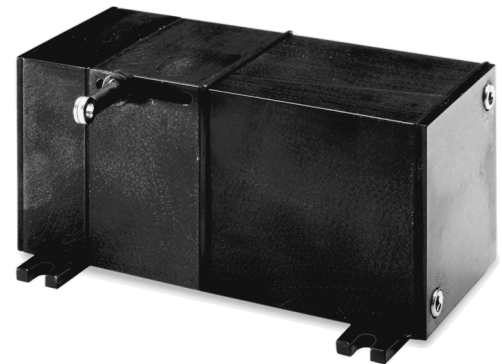

The PT5DN, using a high cycle plastic-hybrid potentiometer, communicates via DeviceNET protocol with programmable controllers in factories and harsh environments requiring linear position measurements in ranges up to 250".

As a member of Celesco's innovative family of NEMA 4 rated cable-extension transducers, the PT5DN installs in minutes by simply mounting it's body to a fixed surface and attaching it's cable to the movable object. Perfect parallel alignment not required.

### Outline Drawing

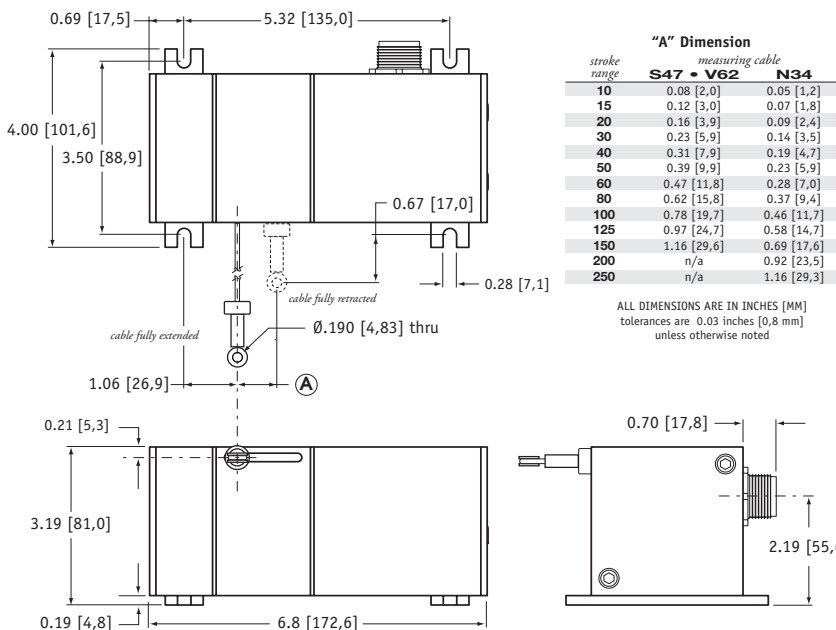

### Output Signal

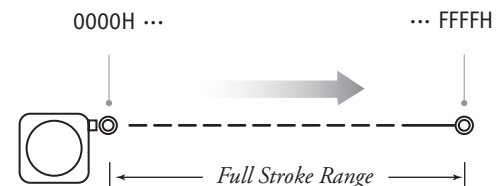

**I/O Format:**

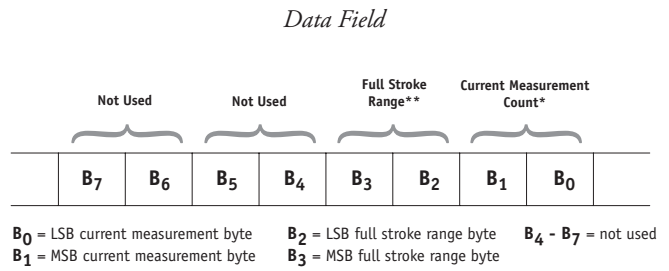
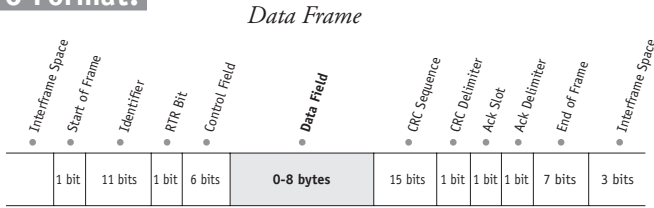

**\*Current Measurement Count**

The **Current Measurement Count (CMC)** is the output data that indicates the present position of the measuring cable.

The CMC is a 16-bit value that occupies the first two bytes (B<sub>0</sub> and B<sub>1</sub>) of the data field. B<sub>0</sub> is the LSB (least significant byte) and B<sub>1</sub> is the MSB (most significant byte).

The CMC starts at 0000H with the measuring cable fully retracted and continues upward to the end of the stroke range stopping at FFFFH. This holds true for all ranges.

**\*\*Full Stroke Range**

The **Full Stroke Range (FSR)** is a 16-bit value in the data field that expresses the full range of the sensor in inches. This value can be used to convert the actual count to units of measurement should the application require it.

The full stroke measurement range occupies the second two bytes (B<sub>2</sub> and B<sub>3</sub>) of the data field.

B<sub>2</sub> is the LSB (least significant byte) and B<sub>3</sub> is the MSB (most significant byte).

This value is expressed in inches.

Example:

Hex Value	Decimal Equivalent	Full Stroke Range
001E	30	30 inches

**Converting CMC to Inches**

If required, the CMC can easily be converted to a linear measurement expressed in inches instead of just counts.

This is accomplished by first dividing the CMC by 65,535 (total counts over the range) and then multiplying that value by the FSR:

$$\left( \frac{\text{CMC}}{65,535} \right) \times \text{FSR}$$

Example:

If the full stroke range is **30 inches** and the current position is **OFF2 Hex** (4082 Decimal) then,

$$\left( \frac{4082}{65,535} \right) \times 30.00 \text{ inches} = 1.87 \text{ inches}$$

**Address Setting (Node ID), Baud Rate and Bus Termination Settings**

**Address Setting (Node ID)**

The Address Setting (Node ID) is set via 6 switches located on the 8-pole DIP switch found on the DeviceNET controller board located inside the transducer.

The DIP switch settings are binary starting with switch number 1 (= 2<sup>0</sup>) and ending with switch number 6 (= 2<sup>5</sup>).

DIP-1 (2 <sup>0</sup> )	DIP-2 (2 <sup>1</sup> )	DIP-3 (2 <sup>2</sup> )	DIP-4 (2 <sup>3</sup> )	DIP-5 (2 <sup>4</sup> )	DIP-6 (2 <sup>5</sup> )	address (decimal)
0	0	0	0	0	0	0
1	0	0	0	0	0	1
0	1	0	0	0	0	2
...	...	...	...	...	...	...
1	1	1	1	1	1	63



**Baud Rate**

The transmission baud rate may be either factory preset at the time of order or set manually at the time of installation.

The baud rate can be set using switches 7 & 8 on the 8-pole DIP switch found on the DeviceNET controller board located inside the transducer.

DIP-7	DIP-8	baud rate
0	0	125k
1	0	250k
0	1	500k
1	1	125k



**Bus Termination**

The setting of the internal bus termination resistor may be specified upon order or manually changed by the end user at the time of installation.

The bus termination resistor is activated setting switches 1 & 2 on the 2-pole DIP switch (located on the internal DeviceNET controller board) to the "ON" position.

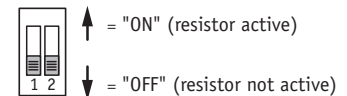

**DeviceNET Controller Board and DIP Switch Location**

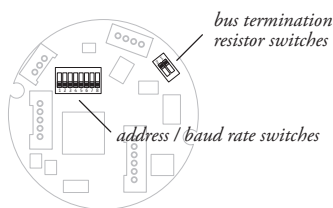

**Caution! Do Not Remove Spring-Side End Cover**  
removing spring-side end cover could cause spring to become unseated and permanently damaged.

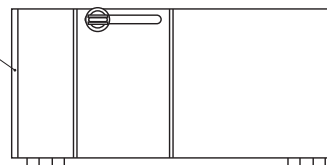

internal dip switches & controller board  
to gain access to the controller board, remove four Allen-Head Screws and remove end cover bracket.

**Ordering Information:**

**Model Number:**

**PT5DN** -      -      -      -      -      -      -       
*order code:*                    **R**            **A**            **B**            **C**            **D**            **E**

Sample Model Number:

**PT5DN - 50 - S47 - FR - 500 - TR - SC5**

- R** range: 50 inches
- A** measuring cable: .047 stainless steel
- B** measuring cable exit: front
- C** baud rate: 500 k bits/sec.
- D** terminating resistor: yes
- E** electrical connection: 5-meter cordset with straight plug

**Full Stroke Range:**

<b>R</b> <i>order code:</i>	10	15	20	25	30	40	50	60	80	100	125	150	200	250	
full stroke range, min:	10 in.	15 in.	20 in.	25 in.	30 in.	40 in.	50 in.	60 in.	80 in.	100 in.	125 in.	150 in.	200 in.	250 in.	
accuracy (±% of f.s.):	.75%	.6%	.5%	.5%	.5%	.3%	.3%	.25%	.25%	.25%	.25%	.18%	.18%	.18%	
repeatability (±% of f.s.):	.1%	.1%	.05%	.05%	.05%	.05%	.05%	.02%	.02%	.02%	.02%	.02%	.02%	.02%	
potentiometer cycle life:	2,500,000 cycles						500,000 cycles						250,000 cycles		
cable tension (20%):	41 ounces											21 ounces			
max. cable velocity/acceleration:	300 in./sec • 5 G's											120 in./sec • 2 G's			

**Measuring Cable:**

<b>A</b> <i>order code:</i>	N34	S47	V62
	.034 nylon-coated stainless steel <i>available in all ranges</i>	.047 stainless steel <i>all ranges up to 150 inches</i>	.062 thermoplastic <i>all ranges up to 150 inches</i>

**Cable Exit:**

<b>B</b> <i>order code:</i>	UP	DN	FR	BK
	up	down	front	back
	inches [mm]			

**Baud Rate:**

<b>C</b> <i>order code:</i>	125	250	500
	125 kbaud	250 kbaud	500 kbaud

**Terminating Resistor:**

<b>D</b> <i>order code:</i>	TR	NR
	terminating resistor	no terminating resistor

Ordering Information (cont.)

**Electrical Connection:**

**B** order code:

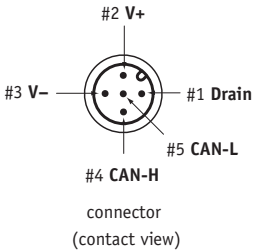
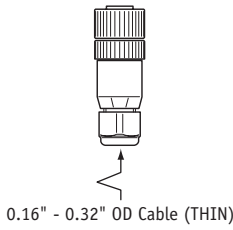
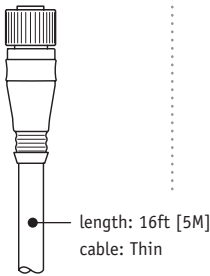
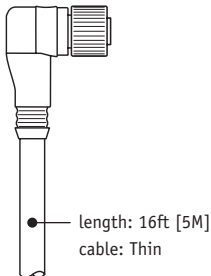
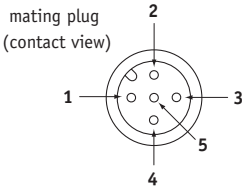
blank	MC5	SC5	NC5																		
5-pin micro-connector (no mating plug supplied)	5-pin micro-connector w/ mating plug	5-pin micro-connector and 5 meter length cordset w/straight mating plug	5-pin micro-connector and 5 meter length cordset w/90° mating plug																		
 <p>#2 V+ #3 V-      #1 Drain #5 CAN-L #4 CAN-H connector (contact view)</p>	 <p>0.16" - 0.32" OD Cable (THIN)</p>	 <p>length: 16ft [5M] cable: Thin</p>	 <p>length: 16ft [5M] cable: Thin</p>																		
	 <p>mating plug (contact view)</p>	<table border="1"> <thead> <tr> <th>pin</th> <th>signal</th> <th>wire color</th> </tr> </thead> <tbody> <tr> <td>1</td> <td>drain</td> <td>brown</td> </tr> <tr> <td>2</td> <td>V+</td> <td>white</td> </tr> <tr> <td>3</td> <td>V-</td> <td>blue</td> </tr> <tr> <td>4</td> <td>Can-H</td> <td>black</td> </tr> <tr> <td>5</td> <td>Can-L</td> <td>grey</td> </tr> </tbody> </table>	pin	signal	wire color	1	drain	brown	2	V+	white	3	V-	blue	4	Can-H	black	5	Can-L	grey	
pin	signal	wire color																			
1	drain	brown																			
2	V+	white																			
3	V-	blue																			
4	Can-H	black																			
5	Can-L	grey																			

version: 2.0 last updated: May 23, 2006